

Article number: 20113036

Description: E+G

Side thrust pin GN 713-10-200-18-SB

Measures

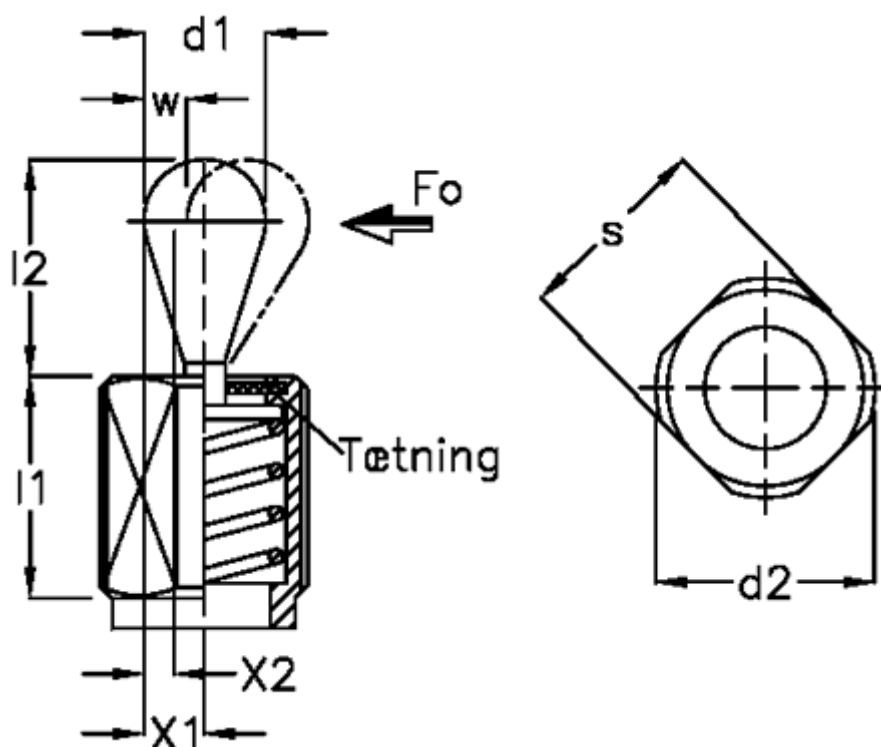

a1 = 5.0

a2 = 10.7

d1 = 10

d2 = M18x1,5

K = 2x45 degrees

l1 = 18.0

l2 = 16.7

l3 = 16

s = 5

screw driver = GN 713.1-5,10

Side power N at l2 = 200

W = 3.2

x1 = 3.4

x2 = 2.7